

KM13

Grooved Nuts



Details:

Main dimensions			
Weight [kg]	≈ 0.203	B [mm]	12
G [mm]	M65x2	b [mm]	7
d ₁ [mm]	79	h [mm]	3
d ₂ [mm]	85		

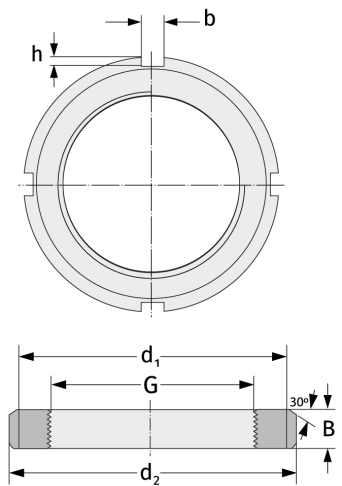

Mating dimensions

Containing components

Securing

MB13