

KM15

Grooved Nuts



Details:

Main dimensions			
Weight [kg]	≈ 0.287	B [mm]	13
G [mm]	M75x2	b [mm]	8
d ₁ [mm]	90	h [mm]	3.5
d ₂ [mm]	98		

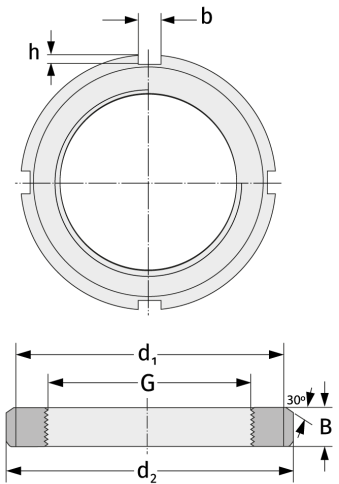

Mating dimensions

Containing components

Securing

MB15