

KM23

Grooved Nuts



Details:

Main dimensions

Weight [kg]	≈ 1.01	B [mm]	19
G [mm]	M115x 2	b [mm]	12
		h [mm]	5
d ₁ [mm]	137		
d ₂ [mm]	150		

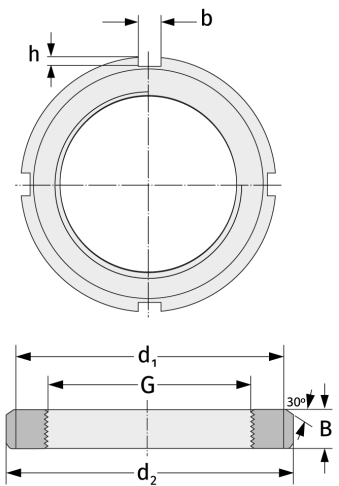

Mating dimensions

Containing components

Securing

MB23