

KM3

Grooved Nuts



Details:

Main dimensions			
Weight [kg]	≈ 0.013	B [mm]	5
G [mm]	M17x1	b [mm]	4
d ₁ [mm]	24	h [mm]	2
d ₂ [mm]	28		

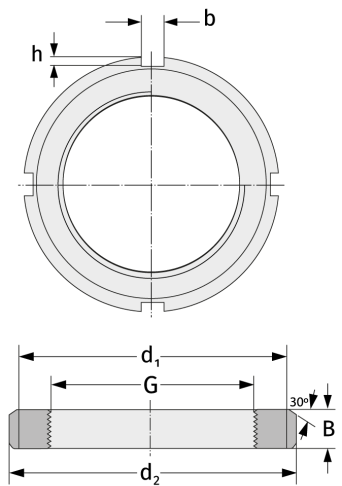

Mating dimensions

Containing components

Securing

MB3