

KM36

Grooved Nuts



Details:

Main dimensions			
Weight [kg]	≈ 3.07	B [mm]	27
G [mm]	M180x 3	b [mm]	18
		h [mm]	8
d ₁ [mm]	203		
d ₂ [mm]	230		

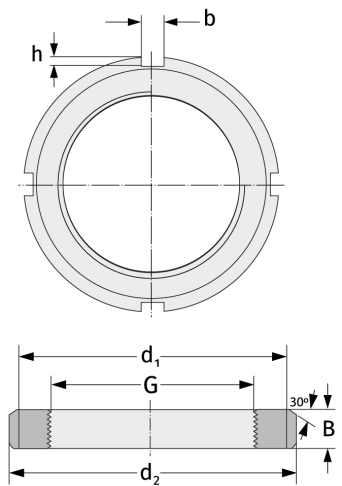

Mating dimensions

Containing components

Securing

MB36