

KML38

Grooved Nuts



Details:

Main dimensions

Weight [kg]	≈ 2.08	B [mm]	28
G [mm]	M190x 3	b [mm]	16
		h [mm]	5
d ₁ [mm]	210		
d ₂ [mm]	220		

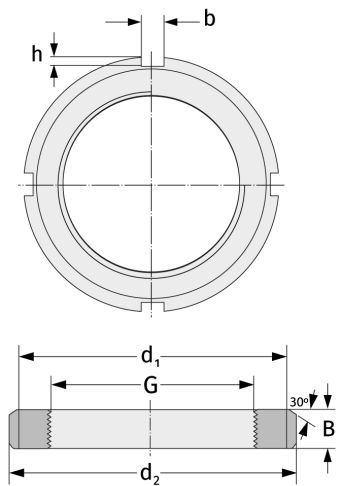

Mating dimensions

Containing components

Securing	MBL28
----------	-------