

MB10

Safety Plates



Details:

Main dimensions

Weight [kg]	≈ 1.6	s [mm]	1.25
d_1 [mm]	50	b_1 [mm]	6
d_2 [mm]	74	b_2 [mm]	6
d_3 [mm]	61	M [mm]	47.5

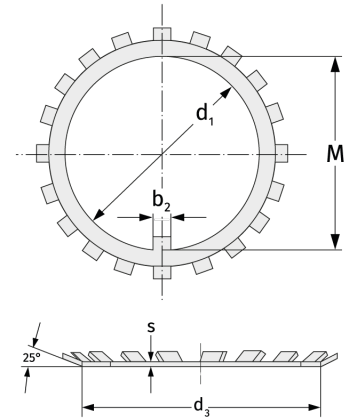

Mating dimensions

Calculation data