

MB12

Safety Plates



Details:

Main dimensions

Weight [kg]	≈ 2.5	s [mm]	1.5
d_1 [mm]	60	b_1 [mm]	7
d_2 [mm]	86	b_2 [mm]	8
d_3 [mm]	73	M [mm]	57.5

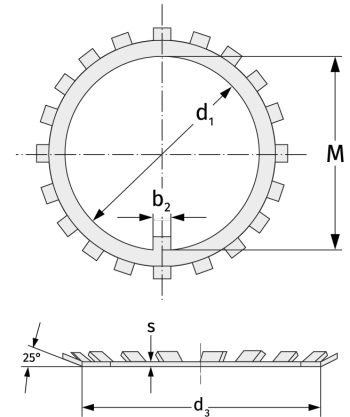

Mating dimensions

Calculation data