

MB25

Safety Plates



Details:

Main dimensions

Weight [kg]	≈ 11.8	s [mm]	2
d_1 [mm]	125	b_1 [mm]	12
d_2 [mm]	170	b_2 [mm]	14
d_3 [mm]	148	M [mm]	120

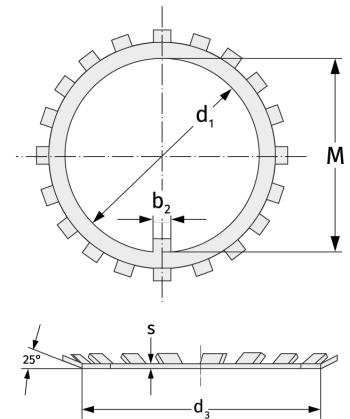

Mating dimensions

Calculation data