

MB26

Safety Plates



Details:

Main dimensions

Weight [kg]	≈ 11.3	s [mm]	2
d_1 [mm]	130	b_1 [mm]	12
d_2 [mm]	175	b_2 [mm]	14
d_3 [mm]	149	M [mm]	125

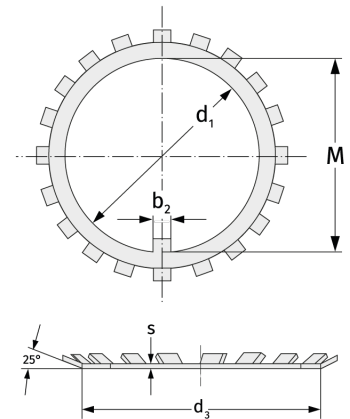

Mating dimensions

Calculation data