

# MB31

Safety Plates



## Details:

### Main dimensions

Weight [kg]	≈ 20.9	s [mm]	2.5
$d_1$ [mm]	155	$b_1$ [mm]	16
$d_2$ [mm]	212	$b_2$ [mm]	16
$d_3$ [mm]	182	M [mm]	147.5

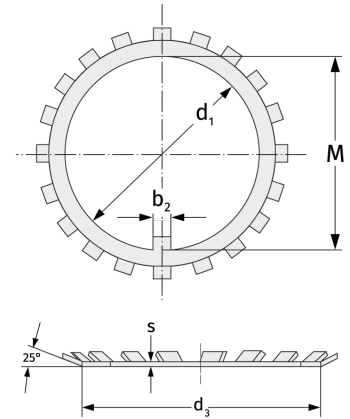

### Mating dimensions

### Calculation data