

MB36

Safety Plates



Details:

Main dimensions

Weight [kg]	≈ 26.8	s [mm]	2.5
d_1 [mm]	180	b_1 [mm]	18
d_2 [mm]	242	b_2 [mm]	20
d_3 [mm]	203	M [mm]	174

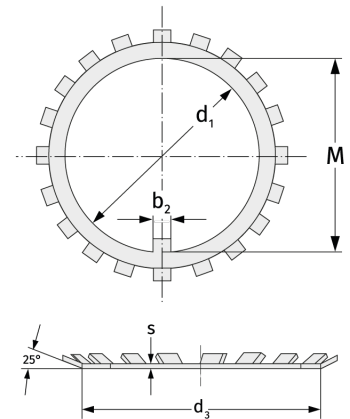

Mating dimensions

Calculation data