

MB4

Safety Plates



Details:

Main dimensions

Weight [kg]	≈ 0.35	s [mm]	1
d_1 [mm]	20	b_1 [mm]	4
d_2 [mm]	36	b_2 [mm]	4
d_3 [mm]	25	M [mm]	18.5

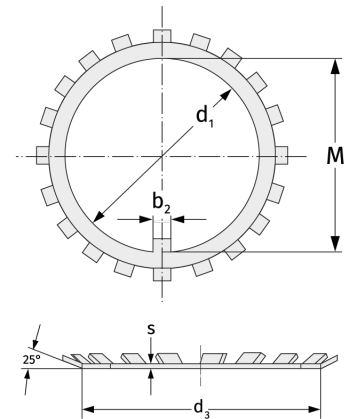

Mating dimensions

Calculation data