

MB44

Safety Plates



Details:

Main dimensions

Weight [kg]	≈ 40	s [mm]	3
d_1 [mm]	220	b_1 [mm]	20
d_2 [mm]	292	b_2 [mm]	24
d_3 [mm]	250	M [mm]	213

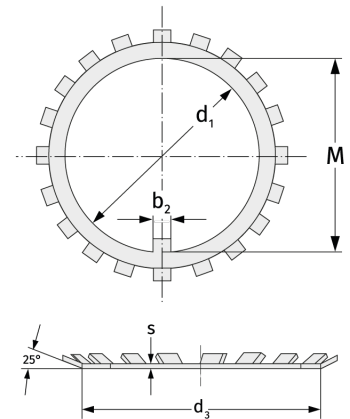

Mating dimensions

Calculation data