

MB56

Safety Plates



Details:

Main dimensions

Weight [kg]	≈ 62	s [mm]	3
d_1 [mm]	280	b_1 [mm]	24
d_2 [mm]	362	b_2 [mm]	28
d_3 [mm]	320	M [mm]	273

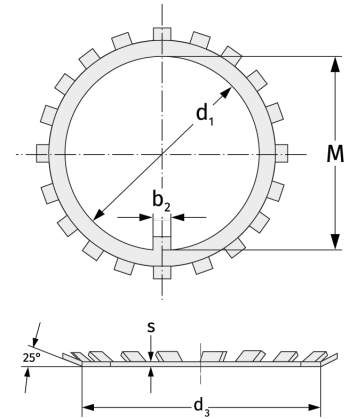

Mating dimensions

Calculation data