

MB8

Safety Plates



Details:

Main dimensions

Weight [kg]	≈ 1.2	s [mm]	1.25
d_1 [mm]	40	b_1 [mm]	6
d_2 [mm]	62	b_2 [mm]	6
d_3 [mm]	50	M [mm]	37.5

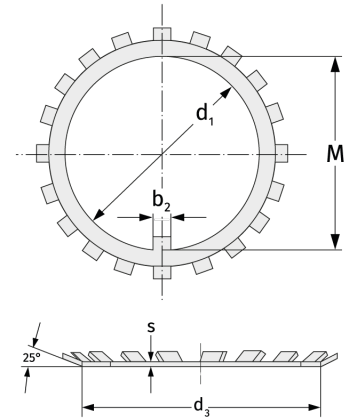

Mating dimensions

Calculation data