

MBL24

Safety Plates



Details:

Main dimensions

Weight [kg]	≈ 7.7	s [mm]	2
d_1 [mm]	120	b_1 [mm]	12
d_2 [mm]	148	b_2 [mm]	14
d_3 [mm]	135	M [mm]	115

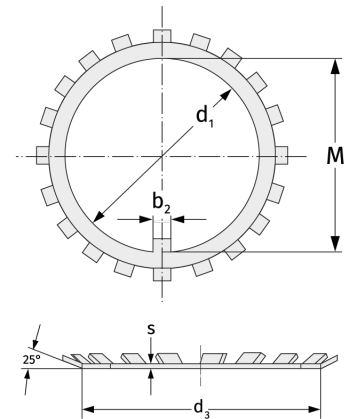

Mating dimensions

Calculation data