

MBL28

Safety Plates



Details:

Main dimensions

Weight [kg]	≈ 10.9	s [mm]	2
d_1 [mm]	140	b_1 [mm]	12
d_2 [mm]	170	b_2 [mm]	16
d_3 [mm]	155	M [mm]	135

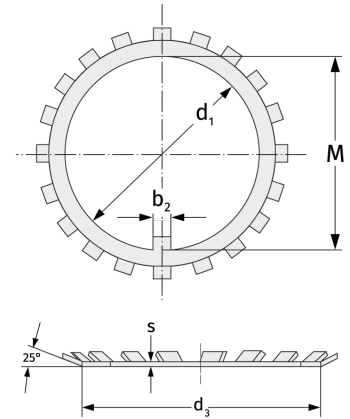

Mating dimensions

Calculation data