

# NCF2220V

Cylindrical Roller Bearings (full complement, single row)



## Details:

### Main dimensions

d [mm]	100	d <sub>1</sub> [mm]	≈ 127.6
D [mm]	180	D <sub>1</sub> [mm]	≈ 153.98
B [mm]	46	r <sub>1,2</sub> [mm]	2.1
Weight [kg]	≈ 5.13	r <sub>3,4</sub> [mm]	2.1
E [mm]	162.78	s [mm]	2.5

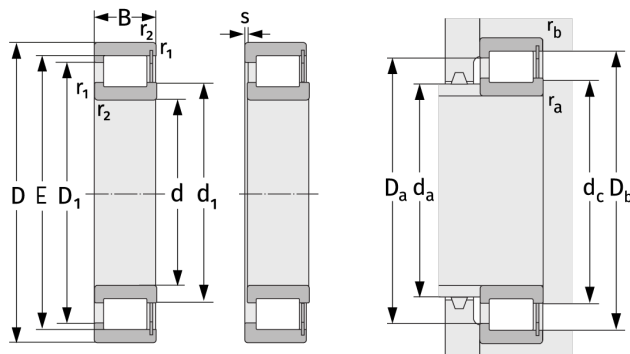

Mating dimensions		Calculation data	
d <sub>a,min</sub> [mm]	112	C [kN]	382
d <sub>c,min</sub> [mm]	126	C <sub>0</sub> [kN]	530
D <sub>a,max</sub> [mm]	168	C <sub>u</sub> [kN]	65.5
D <sub>b,max</sub> [mm]	168	n <sub>th</sub> [min <sup>-1</sup> ]	1686
r <sub>a,max</sub> [mm]	2.1	n <sub>g</sub> [min <sup>-1</sup> ]	2400
r <sub>b,max</sub> [mm]	2.1		