

NJ20/670E.M3

Cylindrical Roller Bearings (single row, with cage)



Details:

Main dimensions

d [mm]	670	d ₁ [mm]	≈ 782
D [mm]	980	D ₁ [mm]	≈ 878
B [mm]	180	r _{1,2} [mm]	7.5
Weight [kg]	≈ 485	r _{3,4} [mm]	7.5
F [mm]	750	s [mm]	9

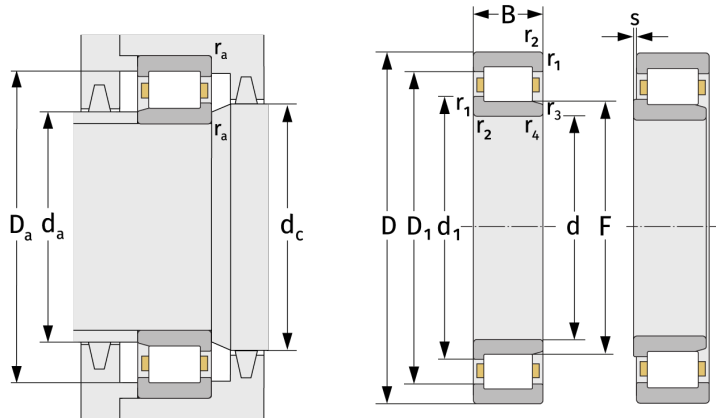

Mating dimensions		Calculation data	
d _{a, min} [mm]	698	C [kN]	5350
d _{a, max} [mm]	745	C ₀ [kN]	11200
d _{b, min} [mm]	755	C _u [kN]	828
d _{c, min} [mm]	787	n _{th} [min ⁻¹]	319
D _{a, max} [mm]	952	n _g [min ⁻¹]	680
r _{a, max} [mm]	6		