

NN3032S.M

Cylindrical Roller Bearings (double row, with cage)



Details:

Main dimensions

d [mm]	160	d ₁ [mm]	≈ 190.2
D [mm]	240	d _s [mm]	4.8
B [mm]	60	n _s [mm]	9.5
Weight [kg]	≈ 9	r _{1,2} [mm]	2.1
E [mm]	219	s [mm]	4.2

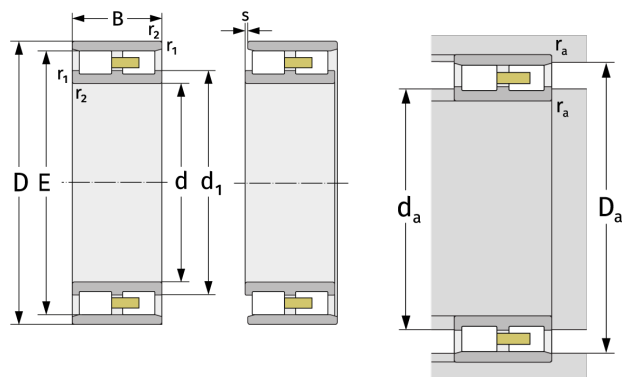

Mating dimensions		Calculation data	
d _{a, min} [mm]	170	C [kN]	378
D _{a, min} [mm]	221	C ₀ [kN]	675
D _{a, max} [mm]	230	C _u [kN]	75.4
r _{a, max} [mm]	2.1	n _{G, Fett} [min ⁻¹]	3200
		n _{G, Öl-Luft} [min ⁻¹]	3800