

NNCF4892V

Cylindrical Roller Bearings (full complement, double row)



Details:

Main dimensions

d [mm]	460	d_s [mm]	8
D [mm]	580	n_s [mm]	15
B [mm]	118	$r_{1,2}$ [mm]	3
Weight [kg]	≈ 76.1	$r_{3,4}$ [mm]	3
d_1 [mm]	≈ 503.3	s [mm]	7
D_1 [mm]	≈ 533.3		

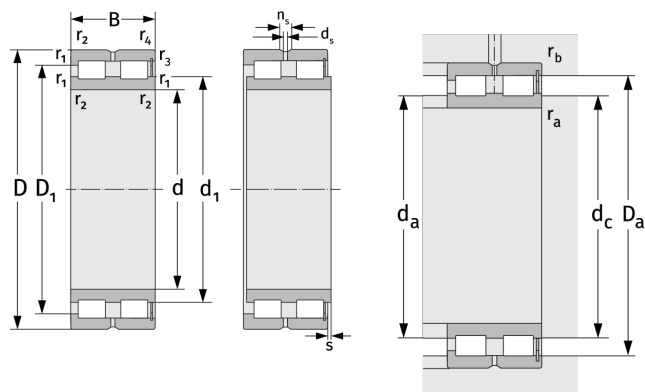

Mating dimensions		Calculation data	
$d_{a, \min}$ [mm]	472.4	C [kN]	1730
$d_{c, \text{empf}}$ [mm]	498	C_0 [kN]	5250
$D_{a, \max}$ [mm]	567.6	C_u [kN]	447
$r_{a, \max}$ [mm]	2.5	n_{th} [min^{-1}]	284
$r_{b, \max}$ [mm]	2.5	n_g [min^{-1}]	560