

NNCF4984V

Cylindrical Roller Bearings (full complement, double row)



Details:

Main dimensions

d [mm]	420	d_s [mm]	4.8
D [mm]	560	n_s [mm]	9.5
B [mm]	140	$r_{1,2}$ [mm]	4
Weight [kg]	≈ 99.1	$r_{3,4}$ [mm]	4
d_1 [mm]	≈ 471.3	s [mm]	7
D_1 [mm]	≈ 509.7		

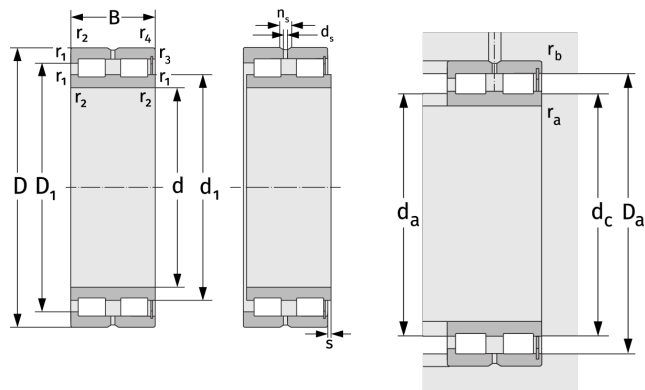

Mating dimensions		Calculation data	
$d_{a, \min}$ [mm]	434.6	C [kN]	2340
$d_{c, \text{empf}}$ [mm]	467	C_0 [kN]	6350
$D_{a, \max}$ [mm]	545.4	C_u [kN]	549
$r_{a, \max}$ [mm]	3	n_{th} [min^{-1}]	278
$r_{b, \max}$ [mm]	3	n_g [min^{-1}]	600