

# NNU4072S.M

Cylindrical Roller Bearings (double row, with cage)



## Details:

### Main dimensions

d [mm]	360	$D_1$ [mm]	≈ 480
D [mm]	540	$d_s$ [mm]	9.5
B [mm]	180	$n_s$ [mm]	17.7
Weight [kg]	≈ 148	$r_{1,2}$ [mm]	5
F [mm]	408	s [mm]	7.4

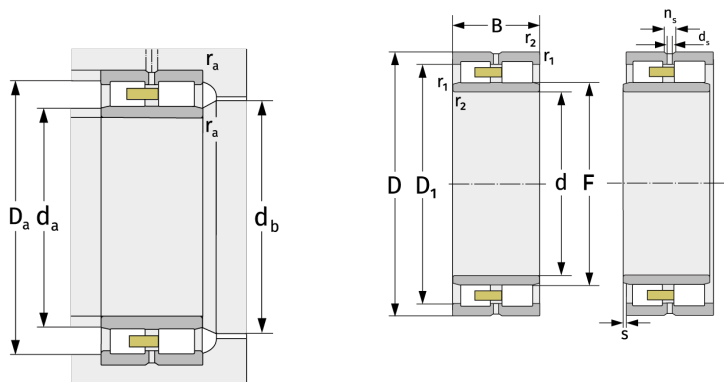

Mating dimensions		Calculation data	
$d_{a, \min}$ [mm]	378	C [kN]	2710
$d_{a, \max}$ [mm]	404	$C_0$ [kN]	5750
$d_{b, \min}$ [mm]	412	$C_u$ [kN]	510
$D_{a, \max}$ [mm]	522	$n_{G, \text{Fett}}$ [ $\text{min}^{-1}$ ]	1300
$r_{a, \max}$ [mm]	4	$n_{G, \text{Öl-Luft}}$ [ $\text{min}^{-1}$ ]	1600