

NNU4080S.M

Cylindrical Roller Bearings (double row, with cage)



Details:

Main dimensions

d [mm]	400	D_1 [mm]	≈ 530
D [mm]	600	d_s [mm]	9.5
B [mm]	200	n_s [mm]	17.7
Weight [kg]	≈ 203	$r_{1,2}$ [mm]	5
F [mm]	450	s [mm]	7.9

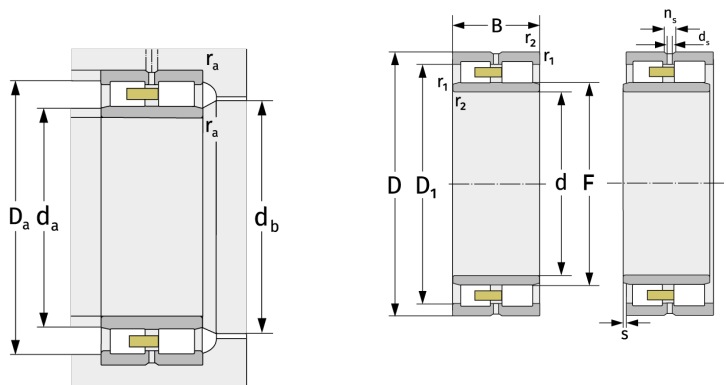

Mating dimensions		Calculation data	
$d_{a, \min}$ [mm]	418	C [kN]	3410
$d_{a, \max}$ [mm]	446	C_0 [kN]	7450
$d_{b, \min}$ [mm]	454	C_u [kN]	645
$D_{a, \max}$ [mm]	582	$n_{G, \text{Fett}}$ [min^{-1}]	1200
$r_{a, \max}$ [mm]	4	$n_{G, \text{Öl-Luft}}$ [min^{-1}]	1400