

NNU41/500S.M

Cylindrical Roller Bearings (double row, with cage)



Details:

Main dimensions

d [mm]	500	D_1 [mm]	≈ 726
D [mm]	830	d_s [mm]	12.5
B [mm]	325	n_s [mm]	23.5
Weight [kg]	≈ 710	$r_{1,2}$ [mm]	7.5
F [mm]	582	s [mm]	14.1

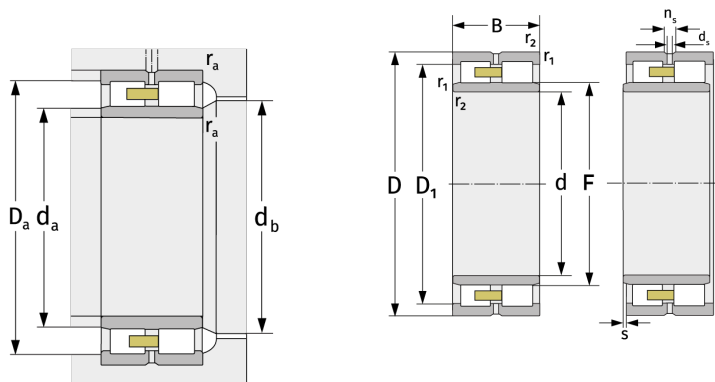

Mating dimensions		Calculation data	
$d_{a, \min}$ [mm]	532	C [kN]	7600
$d_{a, \max}$ [mm]	577	C_0 [kN]	15000
$d_{b, \min}$ [mm]	586	C_u [kN]	1190
$D_{a, \max}$ [mm]	798	$n_{G, \text{Fett}}$ [min^{-1}]	810
$r_{a, \max}$ [mm]	6	$n_{G, \text{Öl-Luft}}$ [min^{-1}]	960