

NNU4872S.M

Cylindrical Roller Bearings (double row, with cage)



Details:

Main dimensions

d [mm]	360	D_1 [mm]	≈ 411.6
D [mm]	440	d_s [mm]	4.8
B [mm]	80	n_s [mm]	9.5
Weight [kg]	≈ 26.4	$r_{1,2}$ [mm]	2.1
F [mm]	386	s [mm]	4.8

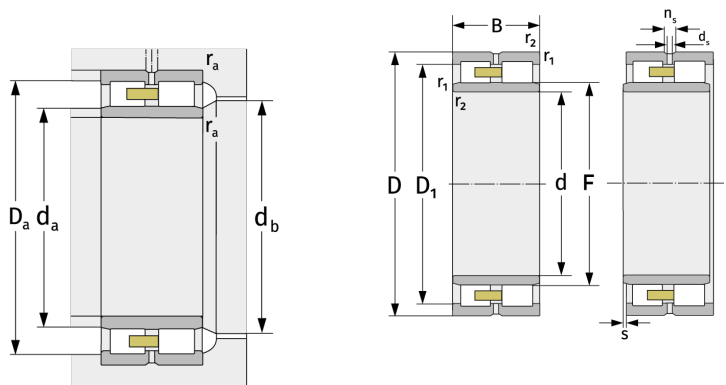

Mating dimensions		Calculation data	
$d_{a, \min}$ [mm]	370	C [kN]	670
$d_{a, \max}$ [mm]	383	C_0 [kN]	1950
$d_{b, \min}$ [mm]	390	C_u [kN]	179
$D_{a, \max}$ [mm]	430	$n_{G, \text{Fett}}$ [min^{-1}]	1500
$r_{a, \max}$ [mm]	2.1	$n_{G, \text{Öl-Luft}}$ [min^{-1}]	1800