

NNU4984S.M

Cylindrical Roller Bearings (double row, with cage)



Details:

Main dimensions

d [mm]	420	D_1 [mm]	≈ 510.8
D [mm]	560	d_s [mm]	9.5
B [mm]	140	n_s [mm]	17.7
Weight [kg]	≈ 98.8	$r_{1,2}$ [mm]	4
F [mm]	466	s [mm]	7.2

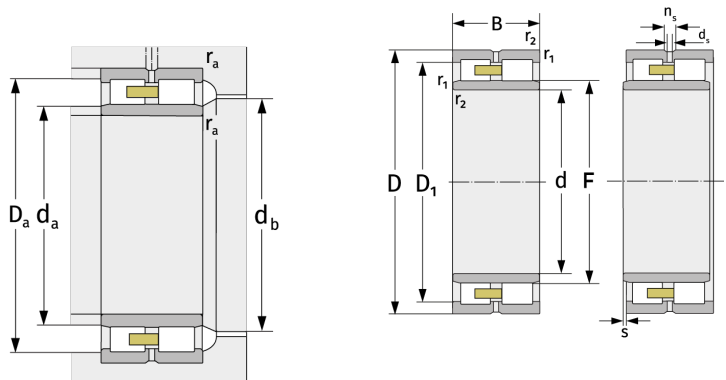

Mating dimensions		Calculation data	
$d_{a, \min}$ [mm]	435	C [kN]	1560
$d_{a, \max}$ [mm]	461	C_0 [kN]	4110
$d_{b, \min}$ [mm]	470	C_u [kN]	355
$D_{a, \max}$ [mm]	545	$n_{G, \text{Fett}}$ [min^{-1}]	1200
$r_{a, \max}$ [mm]	3	$n_{G, \text{Öl-Luft}}$ [min^{-1}]	1400