

NNU6008V

Cylindrical Roller Bearings (full complement, multi row)



Details:

Main dimensions

d [mm]	40	d_s [mm]	3.2
D [mm]	68	n_s [mm]	4.8
B [mm]	50	$r_{1,2}$ [mm]	1
Weight [kg]	≈ 0.82	$r_{3,4}$ [mm]	1
D_1 [mm]	≈ 57.5		

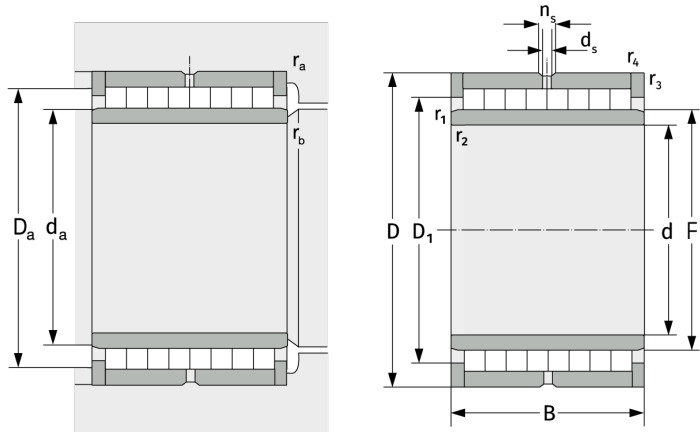

Mating dimensions

$d_{a, \min}$ [mm]	45
$D_{a, \max}$ [mm]	63
$r_{a, \max}$ [mm]	1
$r_{b, \max}$ [mm]	1

Calculation data

C [kN]	112
C_0 [kN]	229
C_u [kN]	30.1