

NNU6011V

Cylindrical Roller Bearings (full complement, multi row)



Details:

Main dimensions

d [mm]	55	d_s [mm]	3.2
D [mm]	90	n_s [mm]	4.8
B [mm]	63	$r_{1,2}$ [mm]	1.1
Weight [kg]	≈ 1.75	$r_{3,4}$ [mm]	1.1
D_1 [mm]	≈ 76.05		

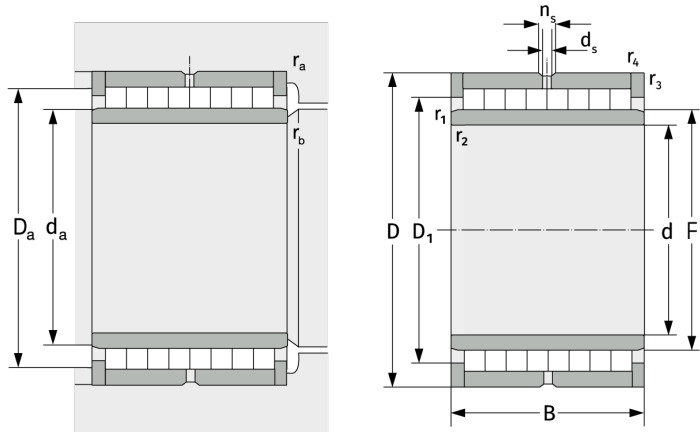

Mating dimensions

$d_{a, \min}$ [mm]	61
$D_{a, \max}$ [mm]	84
$r_{a, \max}$ [mm]	1
$r_{b, \max}$ [mm]	1

Calculation data

C [kN]	210
C_0 [kN]	442
C_u [kN]	58.1