

# NNU6026M

Cylindrical Roller Bearings (multi row, with cage)



## Details:

### Main dimensions

d [mm]	130	$d_s$ [mm]	3.2
D [mm]	200	$n_s$ [mm]	6.5
B [mm]	125	$r_{1,2}$ [mm]	2
Weight [kg]	≈ 15.1	$r_{3,4}$ [mm]	2
F [mm]	152	s [mm]	3.5
$D_1$ [mm]	≈ 174.4		

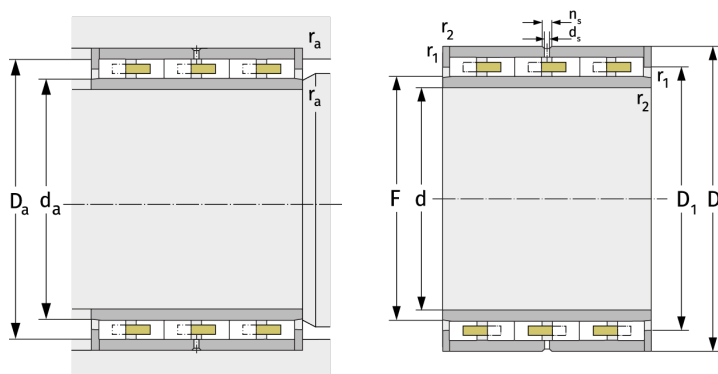

Mating dimensions		Calculation data	
$d_{a, \min}$ [mm]	149	C [kN]	595
$D_{a, \max}$ [mm]	191	$C_0$ [kN]	1350
$r_{a, \max}$ [mm]	2	$C_u$ [kN]	159
$r_{b, \max}$ [mm]	2	$n_g$ [ $\text{min}^{-1}$ ]	3500