

NNU6036V

Cylindrical Roller Bearings (full complement, multi row)



Details:

Main dimensions

d [mm]	180	d_s [mm]	3.2
D [mm]	280	n_s [mm]	6.5
B [mm]	180	$r_{1,2}$ [mm]	2.1
Weight [kg]	≈ 45.3	$r_{3,4}$ [mm]	2.1
D_1 [mm]	≈ 242.5		

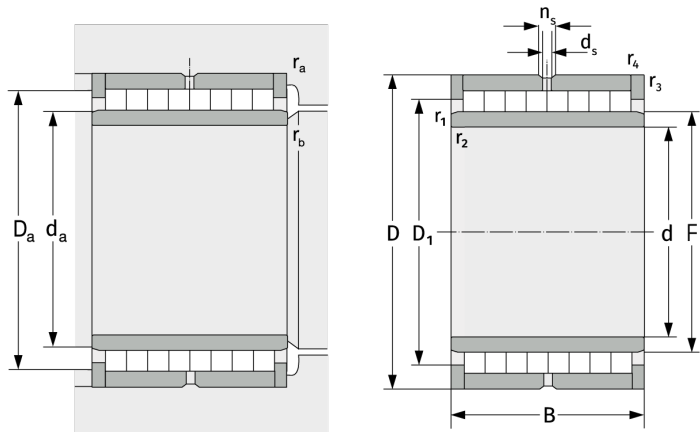

Mating dimensions

$d_{a, \min}$ [mm]	190
$D_{a, \max}$ [mm]	270
$r_{a, \max}$ [mm]	2.1
$r_{b, \max}$ [mm]	2.1

Calculation data

C [kN]	1640
C_0 [kN]	4310
C_u [kN]	462