

NNU6944V

Cylindrical Roller Bearings (full complement, multi row)



Details:

Main dimensions

d [mm]	220	d_s [mm]	3.2
D [mm]	300	n_s [mm]	6.5
B [mm]	145	$r_{1,2}$ [mm]	2.1
Weight [kg]	≈ 32.9	$r_{3,4}$ [mm]	2.1
D_1 [mm]	≈ 270.35		

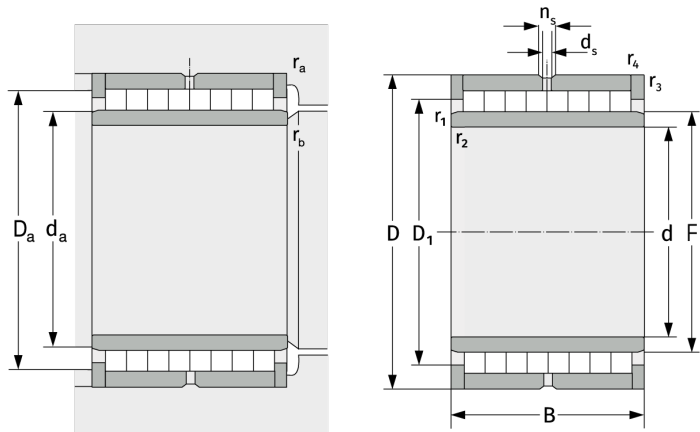

Mating dimensions

$d_{a, \min}$ [mm]	230
$D_{a, \max}$ [mm]	290
$r_{a, \max}$ [mm]	2.1
$r_{b, \max}$ [mm]	2.1

Calculation data

C [kN]	1310
C_0 [kN]	4000
C_U [kN]	414