

NNU6956V

Cylindrical Roller Bearings (full complement, multi row)



Details:

Main dimensions

d [mm]	280	d_s [mm]	4.8
D [mm]	380	n_s [mm]	9.5
B [mm]	180	$r_{1,2}$ [mm]	2.1
Weight [kg]	≈ 64.9	$r_{3,4}$ [mm]	2.1
D_1 [mm]	≈ 344.5		

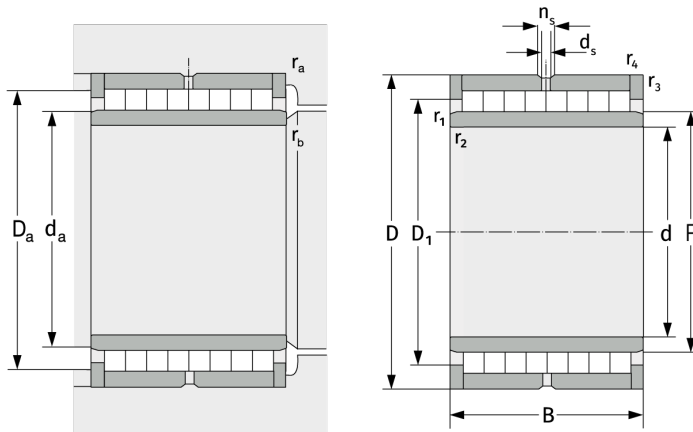

Mating dimensions

$d_{a, \min}$ [mm]	290
$D_{a, \max}$ [mm]	370
$r_{a, \max}$ [mm]	2.1
$r_{b, \max}$ [mm]	2.1

Calculation data

C [kN]	2010
C_0 [kN]	6400
C_u [kN]	618