

QJ340MPA

Four Point Contact Ball Bearings (metric)



Details:

Main dimensions

d [mm]	200	D_1 [mm]	≈ 340.9
D [mm]	420	$r_{1,2}$ [mm]	5
B [mm]	80	α_0 [°]	35
Weight [kg]	≈ 61.6	a [mm]	≈ 217
d_1 [mm]	≈ 279.1		

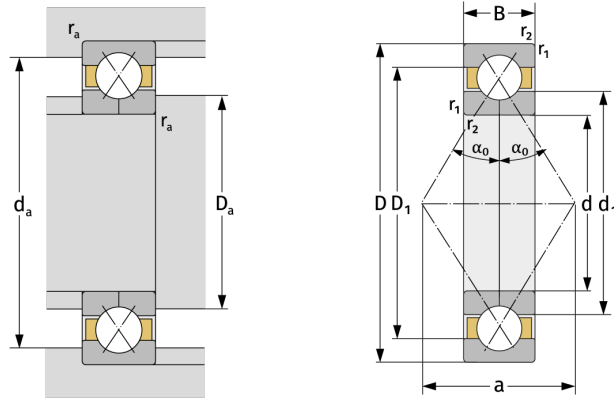

Mating dimensions

$d_{a, \min}$ [mm]	220
$D_{a, \max}$ [mm]	400
$r_{a, \max}$ [mm]	4

Calculation data

C [kN]	760
C_0 [kN]	1270
C_u [kN]	35.6
n_{th} [min ⁻¹]	1269
n_g [min ⁻¹]	2700