

30240

Kegelrollenlager (einreihig, metrisch)



Details:

Hauptabmessungen			
d [mm]	200	B [mm]	58
D [mm]	360	d ₁ [mm]	≈ 271,2
T [mm]	64	r _{1,2} [mm]	5
Gewicht [kg]	≈ 24,7	r _{3,4} [mm]	4
		a [mm]	≈ 68,5
C [mm]	48		

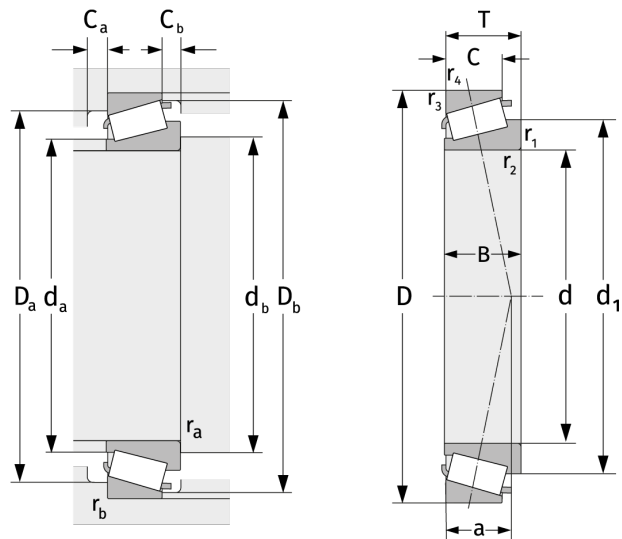

Anschlussmaße		Berechnungsdaten	
d _{a,max} [mm]	237	C [kN]	810
d _{b,min} [mm]	217	C ₀ [kN]	1150
D _{a,min} [mm]	315	C _u [kN]	105
D _{a,max} [mm]	342	n _{th} [min ⁻¹]	1253
D _{b,min} [mm]	336	n _g [min ⁻¹]	1800
C _{a,min} [mm]	9	e	0,44
C _{b,min} [mm]	16	Y	1,38
r _{a,max} [mm]	5	Y ₀	0,76
r _{b,max} [mm]	4		