

30256

Kegelrollenlager (einreihig, metrisch)



Details:

Hauptabmessungen			
d [mm]	280	B [mm]	80
D [mm]	500	d ₁ [mm]	≈ 375,3
T [mm]	89	r _{1,2} [mm]	6
Gewicht [kg]	≈ 65,5	r _{3,4} [mm]	5
		a [mm]	≈ 94,8
C [mm]	67		

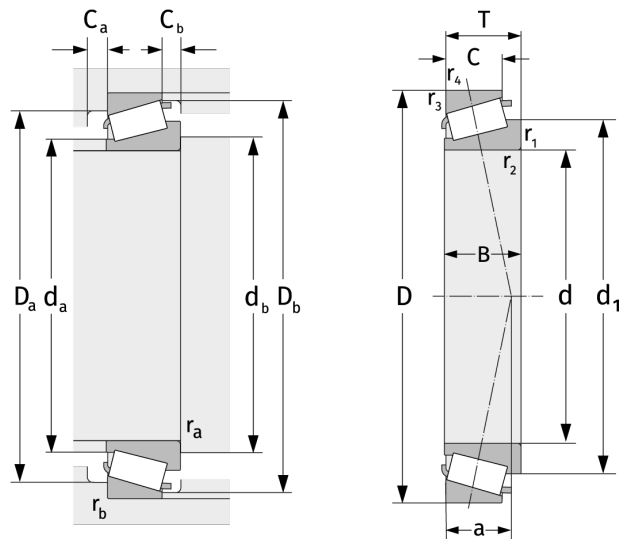

Anschlussmaße		Berechnungsdaten	
d _{a,max} [mm]	330	C [kN]	1480
d _{b,min} [mm]	300	C ₀ [kN]	2210
D _{a,min} [mm]	433	C _u [kN]	186
D _{a,max} [mm]	477	n _{th} [min ⁻¹]	801
D _{b,min} [mm]	465	n _g [min ⁻¹]	1300
C _{a,min} [mm]	12	e	0,44
C _{b,min} [mm]	22	Y	1,38
r _{a,max} [mm]	6	Y ₀	0,76
r _{b,max} [mm]	5		