

# 30340

Kegelrollenlager (einreihig, metrisch)

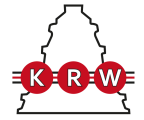

## Details:

Hauptabmessungen			
d [mm]	200	B [mm]	80
D [mm]	420	d <sub>1</sub> [mm]	≈ 292
T [mm]	89	r <sub>1,2</sub> [mm]	6
Gewicht [kg]	≈ 51,3	r <sub>3,4</sub> [mm]	5
		a [mm]	≈ 72,5
C [mm]	67		

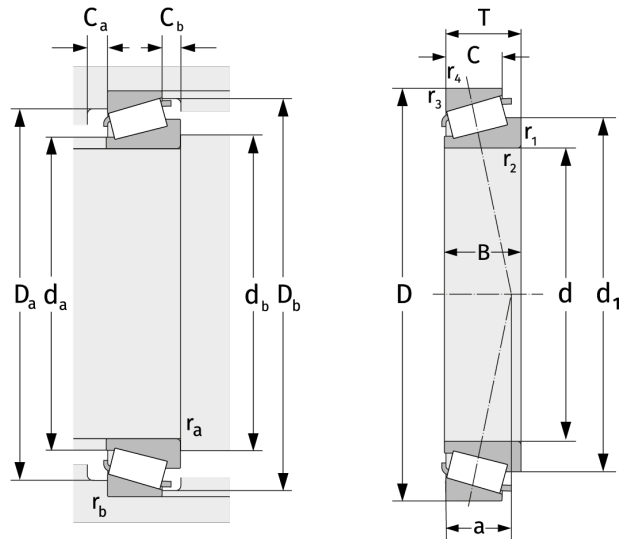

Anschlussmaße		Berechnungsdaten	
d <sub>a,max</sub> [mm]	250	C [kN]	1270
d <sub>b,min</sub> [mm]	220	C <sub>0</sub> [kN]	1660
D <sub>a,min</sub> [mm]	360	C <sub>u</sub> [kN]	147
D <sub>a,max</sub> [mm]	397	n <sub>th</sub> [min <sup>-1</sup> ]	1132
D <sub>b,min</sub> [mm]	385	n <sub>g</sub> [min <sup>-1</sup> ]	1700
C <sub>a,min</sub> [mm]	10	e	0,35
C <sub>b,min</sub> [mm]	22	Y	1,74
r <sub>a,max</sub> [mm]	6	Y <sub>0</sub>	0,96
r <sub>b,max</sub> [mm]	5		