

32256

Kegelrollenlager (einreihig, metrisch)



Details:

Hauptabmessungen			
d [mm]	280	B [mm]	130
D [mm]	500	d ₁ [mm]	≈ 389
T [mm]	137	r _{1,2} [mm]	6
Gewicht [kg]	≈ 111	r _{3,4} [mm]	5
		a [mm]	≈ 117,9
C [mm]	106		

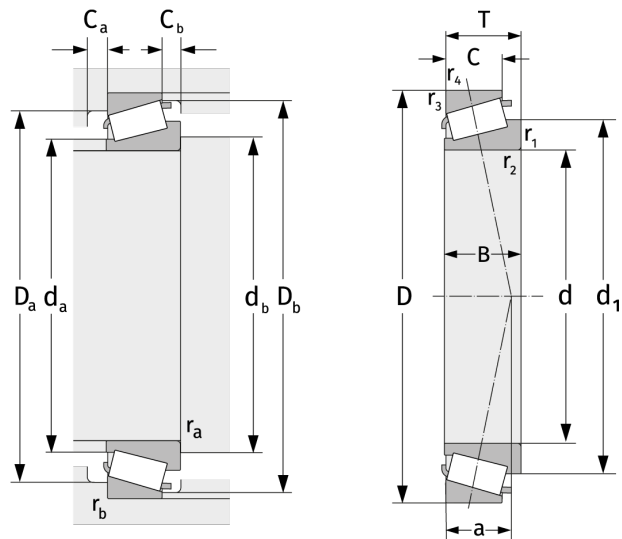

Anschlussmaße		Berechnungsdaten	
d _{a,max} [mm]	322	C [kN]	2340
d _{b,min} [mm]	300	C ₀ [kN]	4070
D _{a,min} [mm]	418	C _u [kN]	342
D _{a,max} [mm]	477	n _{th} [min ⁻¹]	638
D _{b,min} [mm]	475	n _g [min ⁻¹]	1300
C _{a,min} [mm]	14	e	0,45
C _{b,min} [mm]	31	Y	1,33
r _{a,max} [mm]	6	Y ₀	0,73
r _{b,max} [mm]	5		