

H24060

Spannhülsen



Details:

Hauptabmessungen

d [mm]	300	B ₃ [mm]	54
Gewicht [kg]	≈ 26,9	G [mm]	Tr300x 4
d ₁ [mm]	280	G ₁ [mm]	M6
d ₂ [mm]	360	l _{G1} [mm]	7
B ₁ [mm]	220	a [mm]	4,2
B ₂ [mm]	42		

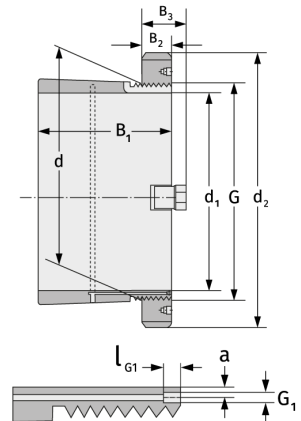

Anschlussmaße

Enthaltene Komponenten

Nut-/Wellenmutter	HM3060
Sicherung	MS3060