

HM30/1000

Nutmuttern



Details:

Hauptabmessungen

Gewicht [kg]	≈ 170	B [mm]	100
G [mm]	Tr1000 x8	b [mm]	60
d ₁ [mm]	1085	h [mm]	25
d ₂ [mm]	1140		

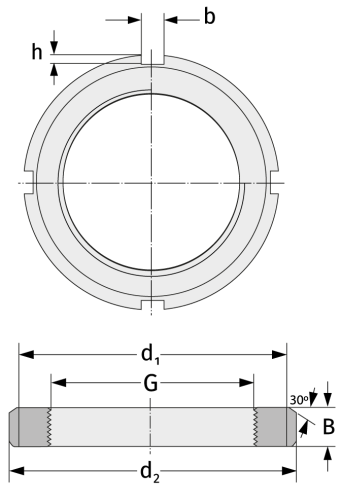

Anschlussmaße

Enthaltene Komponenten

Sicherung

MS30/100

0