

HM30/1060

Nutmuttern



Details:

Hauptabmessungen			
Gewicht [kg]	≈ 180	B [mm]	100
G [mm]	Tr1060 x8	b [mm]	60
d ₁ [mm]	1145	h [mm]	25
d ₂ [mm]	1200		

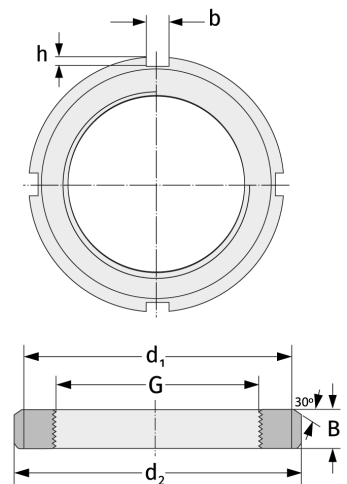

Anschlussmaße	Enthaltene Komponenten	
	Sicherung	MS30/100 0