

HM3044

Nutmuttern



Details:

Hauptabmessungen			
Gewicht [kg]	≈ 3,09	B [mm]	30
		b [mm]	20
G [mm]	Tr220x 4	h [mm]	9
d ₁ [mm]		242	
d ₂ [mm]	260		

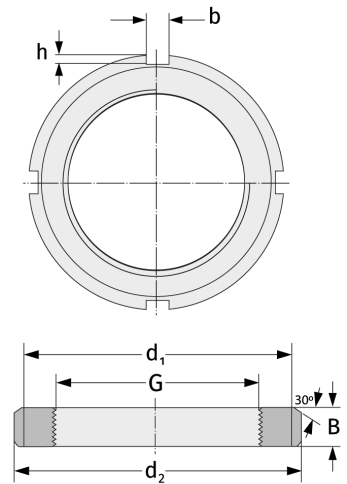

Anschlussmaße	Enthaltene Komponenten	
	Sicherung	MS3044