

HM3060

Nutmuttern



Details:

Hauptabmessungen			
Gewicht [kg]	≈ 9,62	B [mm]	42
		b [mm]	24
G [mm]	Tr300x 4	h [mm]	12
d ₁ [mm]		336	
d ₂ [mm]	360		

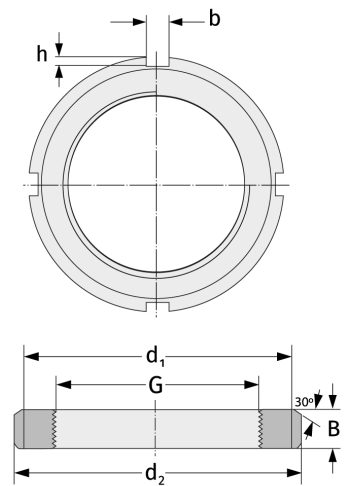

Anschlussmaße	Enthaltene Komponenten	
	Sicherung	MS3060