

HM3068

Nutmuttern



Details:

Hauptabmessungen			
Gewicht [kg]	≈ 11,7	B [mm]	45
		b [mm]	24
G [mm]	Tr340x 5	h [mm]	12
d ₁ [mm]		376	
d ₂ [mm]	400		

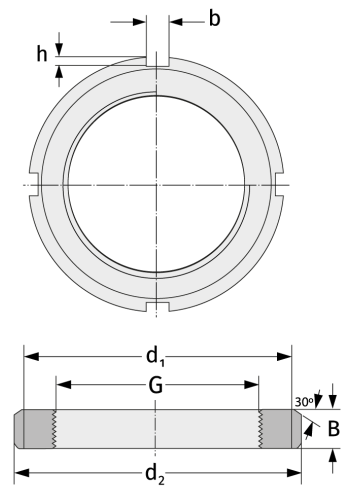

Anschlussmaße	Enthaltene Komponenten	
	Sicherung	MS3064