

HM3080

Nutmuttern



Details:

Hauptabmessungen

Gewicht [kg]	≈ 16,9	B [mm]	52
G [mm]	Tr400X 5	b [mm]	28
d ₁ [mm]	442	h [mm]	14
d ₂ [mm]	470		

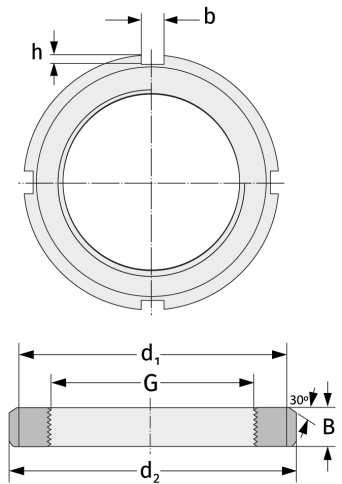

Anschlussmaße	Enthaltene Komponenten	
	Sicherung	MS3076