

HM3084

Nutmuttern



Details:

| Hauptabmessungen | | | |
|---------------------|-------------|--------|----|
| Gewicht [kg] | ≈ 17,4 | B [mm] | 52 |
| | | b [mm] | 32 |
| G [mm] | Tr420x 5 | h [mm] | 14 |
| d ₁ [mm] | | 462 | |
| d ₂ [mm] | 490 | | |

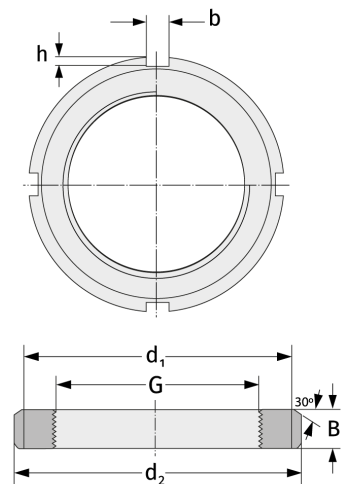

| Anschlussmaße | Enthaltene Komponenten | |
|---------------|------------------------|--------|
| | Sicherung | MS3084 |