

HM3088

Nutmuttern



Details:

Hauptabmessungen			
Gewicht [kg]	≈ 26,2	B [mm]	60
		b [mm]	32
G [mm]	Tr440x 5	h [mm]	15
d ₁ [mm]		490	
d ₂ [mm]	520		

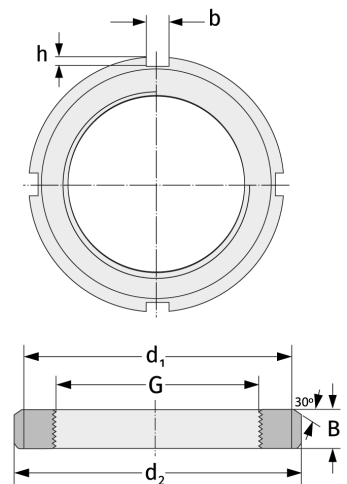

Anschlussmaße	Enthaltene Komponenten	
	Sicherung	MS3088