

HM31/1000

Nutmuttern



Details:

Hauptabmessungen			
Gewicht [kg]	≈ 374	B [mm]	125
G [mm]	Tr1000 x8	b [mm]	70
d ₁ [mm]	1140	h [mm]	38
d ₂ [mm]	1240		

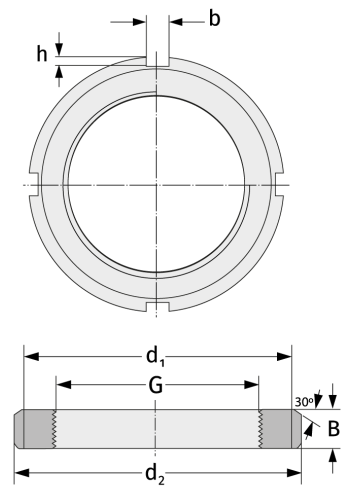

Anschlussmaße	Enthaltene Komponenten	
	Sicherung	MS31/100 0