

HM31/600

Nutmuttern



Details:

Hauptabmessungen

Gewicht [kg]	≈ 94,9	B [mm]	85
G [mm]	Tr600x6	b [mm]	45
d ₁ [mm]	690	h [mm]	25
d ₂ [mm]	750		

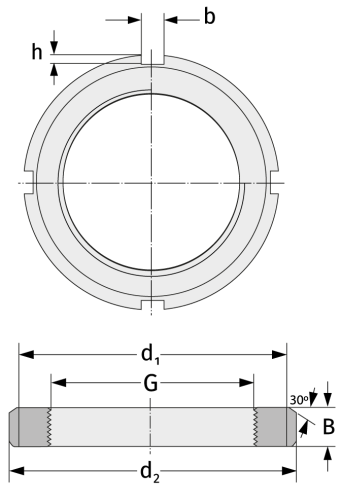

Anschlussmaße

Enthaltene Komponenten

Sicherung

MS31/560